

**Product Introduction
and Scope of Supply**



PRODUCT INTRODUCTION AND SCOPE OF SUPPLY

FOR CHENGDU HOLY CRYOGENIC EQUIPMENT CO.,LTD.

English Version

TABLE OF CONTENTS

Brief of the Company.....	4
Vacuum Insulated/Jacketed Pipe.....	5
1.1 Type of Connection	7
1.2 Product Scope of Supply	10
1.3 Specification and Model	12
Vacuum Insulated/Jacketed Flexible Hose.....	15
2.1 Type of Connection	17
2.2 Two Protective Covers	19
2.3 Product Scope of Supply	20
2.4 Specification and Model	22
Dynamic Vacuum System	26
3.1 Dynamic Vacuum System	27
Vacuum Insulated Phase Separator	30
4.1 Three Kinds of Phase Separators.....	32
Vacuum Insulated Valve Series.....	40
5.1 Vacuum Insulated Shut-off Valve.....	41
5.2 Vacuum Insulated Pneumatic Shut-off Valve.....	42
5.3 Vacuum Insulated Pressure Regulating Valve.....	43
5.4 Vacuum Insulated Flow Regulating Valve.....	44

5.5 Vacuum Insulated Check Valve	45
5.6 Vacuum Insulated Valve Box	46
Accessories Series	47
6.1 Vacuum Insulated Filter	48
6.2 Venting Pipe Heater	49
6.3 Safety Relief Valve (Group).....	50
6.4 Vacuum Insulated Gas-liquid Barrier.....	51
6.5 Special Connector for Cold-box and Storage Tank.....	52
6.6 Cryogenic Liquid Vaporizer	54
Products and Solutions in Some Special Industries	55
7.1 MBE Project in Chip & Semiconductor Industry	56
7.2 Air Separation Plants.....	57
7.3 Liquefied Natural Gas (LNG) Industry	59
7.4 Cryogenic Assembly in Automotive Engine/Motor Rotor Industry	60
7.5 Lamp Manufacturing Industry	61
7.6 Bioengineering and Pharmacy Industry	62

Brief of the Company

HL Cryogenic Equipment which was founded in 1992 is a brand affiliated to **Chengdu Holy Cryogenic Equipment Co.,Ltd.** HL Cryogenic Equipment is committed to the design and manufacture of the High Vacuum Insulated Cryogenic Piping System and related Support Equipment to meet the various needs of customers. After decades of development, HL Cryogenic Equipment has become a solution provider for the cryogenic applications, including R&D, design, manufacturing and post-production, with the capability of "discovering customer problems", "solving customer problems" and "improving customer systems".

In order to gain the trust of more international customers and realize the internationalization process of the company, HL Cryogenic Equipment has established **ASME, CE, and ISO9001 system certification.** HL Cryogenic Equipment actively takes part in the cooperation with universities, research institutions and international Companies.



(Project with Thermo Fisher Scientific)

**Product Introduction
and Scope of Supply**



Vacuum Insulated/Jacketed Pipe

PRODUCT INTRODUCTION

AND SCOPE OF SUPPLY

FOR CHENGDU HOLY CRYOGENIC EQUIPMENT CO.,LTD.

1 Vacuum Insulated/Jacketed Pipe

The product series of Vacuum Insulated Pipe, Vacuum Insulated Hose, Vacuum Insulated Valve, and Phase Separator in HL Cryogenic Equipment Company, which passed through a series of extremely strict technical treatments, are used for transferring of liquid oxygen, liquid nitrogen, liquid argon, liquid hydrogen, liquid helium, LEG and LNG, and these products are serviced for cryogenic equipment (e.g. cryogenic tanks, dewars and coldboxes etc.) in industries of air separation, gases, aviation, electronics, superconductor, chips, automation assembly, food & beverage, pharmacy, hospital, biobank, rubber, new material manufacturing chemical engineering, iron & steel, and scientific research etc.



High-vacuum Multi-layer Multi-shield Insulated Cryogenic Pipe, hereinafter referred to as Vacuum Insulated Pipe (VI Piping), namely Vacuum Jacketed Pipe (VJ Piping), which is as a Perfect substitute for conventional piping insulation. Compared with conventional piping insulation, the heat leakage value of VIP is only 0.05~0.035 times of conventional piping insulation. Significantly save energy and cost for customers.

Products of Chengdu Holy are built to ASME B31.3 Pressure Piping code as the standard.

1.1 Type of Connection

The three connection types here apply only to the connection positions between VI pipes. **When VI Pipe connects with equipment, storage tank and so on, the connection joint can be customized according to customer requirements.**

In order to maximize the different needs of customers, Vacuum Insulated Pipe has developed three connection types, namely Vacuum Bayonet Connection Type with Clamps, Vacuum Bayonet Connection Type with Flanges and Bolts and Welded Connection Type. They have different advantages and are suitable for different working conditions.

	Vacuum Bayonet Connection Type with Clamps	Vacuum Bayonet Connection Type with Flanges and Bolts	Welded Connection Type
Connection Type	Clamps	Flanges and Bolts	Weld
Insulation Type at joints	Vacuum	Vacuum	Perlite or Vacuum
On-site Insulated Treatment	No	No	Yes, perlite filled into or vacuum pump out from the Insulated Sleeves at joints.
Nominal Diameter of Inner Pipe	DN10(3/8")~DN25(1")	DN10(3/8")~DN80(3")	DN10(3/8")~DN500(20")
Design Pressure	≤8 bar	≤16 bar	≤64 bar
Installation	Easy	Easy	Weld
Design Temperature	-196°C~ 60°C (LH2 & LHe : -270°C ~ 60°C)		
Length	1 ~ 8.2 meter/pcs		
Material	300 Series Stainless Steel		
Medium	LN ₂ , LOX, LAr, LHe, LH ₂ , LNG		

Product Introduction and Scope of Supply



Vacuum Bayonet Connection Type Vacuum Insulated Pipe



Welded Connection Type Vacuum Insulated Pipe

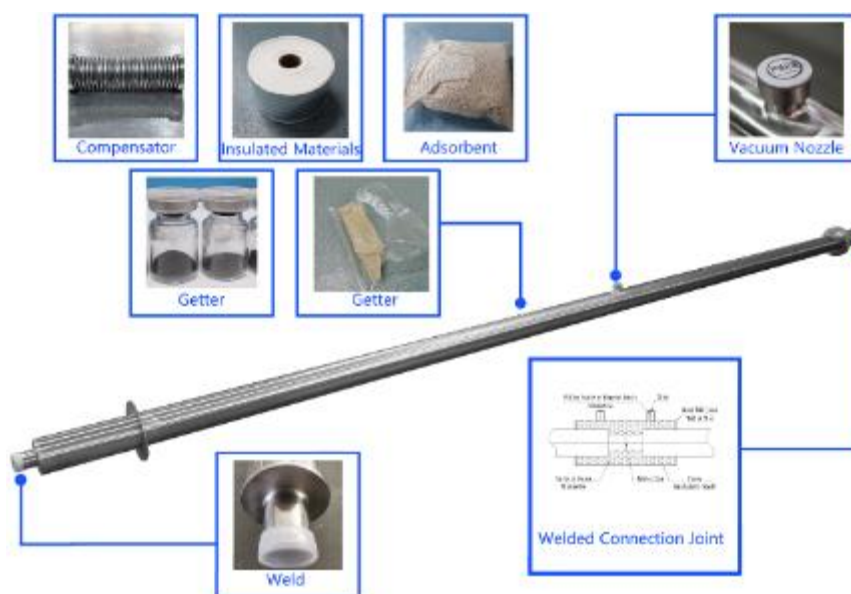

Pictures of Connection Types



Vacuum Bayonet Connection Type with Clamps



Vacuum Bayonet Connection Type with Flanges and Bolts



Welded Connection Type

1.2 Product Scope of Supply

Vacuum Insulated Pipeline

Product	Specification	Vacuum Bayonet Connection with Clamps	Vacuum Bayonet Connection with Flanges and Bolts	Weld Insulated Connection
Vacuum Insulated Pipe	DN8	YES	YES	YES
	DN15	YES	YES	YES
	DN20	YES	YES	YES
	DN25	YES	YES	YES
	DN32	/	YES	YES
	DN40	/	YES	YES
	DN50	/	YES	YES
	DN65	/	YES	YES
	DN80	/	YES	YES
	DN100	/	/	YES
	DN125	/	/	YES
	DN150	/	/	YES
	DN200	/	/	YES
	DN250	/	/	YES
	DN300	/	/	YES
	DN400	/	/	YES
DN500	/	/	YES	

Specification of inner/core pipes can meet the requirements of users, specification of outer pipes follow the company standards.

Product Introduction and Scope of Supply



Technical Characteristic of VI Pipe

Pipe Diameter	As shown in the 1.3 Specification and Model
Pipe Design Pressure	As shown in the 1.3 Specification and Model
Compensator Design Pressure	≥4.0MPa
Design Temperature	-196C~90°C (LHe: -270~90°C)
Ambient Temperature	-50~90°C
Vacuum Leakage Rate	≤1*10 ⁻¹⁰ Pa·m ³ /S
Vacuum Level after Guarantee	≤0.1 Pa
Insulated Method	High Vacuum Multi-Layer Insulation.
Adsorbent and Getter	Yes
NDE	100% Radiographic Examination
Test Pressure	1.15 Times Design Pressure
Medium	LO ₂ 、LN ₂ 、LAr、LH ₂ 、LHe、LEG、LNG



1.3 Specification and Model

Vacuum Bayonet Connection Type with Clamps of VI Pipe

Model	Connection Type	Nominal Diameter of Inner Pipe	Design Pressure	Material of Inner Pipe	Standard	Remark
HLP SB01008X	Vacuum Bayonet Connection Type with Clamps for Static Vacuum Insulated Piping System	DN10, 3/8"	8 bar	300 Series Stainless Steel	ASME B31.3	X: Material of Inner Pipe. A is 304, B is 304L, C is 316, D is 316L, E is other.
HLP SB01508X		DN15, 1/2"				
HLP SB02008X		DN20, 3/4"				
HLP SB02508X		DN25, 1"				

Nominal Diameter of Inner Pipe: Recommended \leq DN25 or 1". Or selects the Vacuum Bayonet Connection Type with Flanges and Bolts (from DN10, 3/8" to DN80, 3"), Welded Connection Type VIP (from DN10, 3/8" to DN500, 20")

Nominal Diameter of Outer Pipe: Recommended by the Enterprise Standard of HL Cryogenic Equipment. It also can be produced according to requirement of the customer.

Design Pressure: Recommended \leq 8 bar. Or selects the Vacuum Bayonet Connection Type with Flanges and Bolts (\leq 16 bar), Welded Connection Type (\leq 64 bar)

Material of Outer Pipe: Without special requirement, the material of inner pipe and outer pipe will be selected the same.



Product Introduction and Scope of Supply



Vacuum Bayonet Connection Type with Flanges and Bolts of VI Pipe

Model	Connection Type	Nominal Diameter of Inner Pipe	Design Pressure	Material of Inner Pipe	Standard	Remark
HLPSF01000X	Vacuum Bayonet Connection Type with Flanges and Bolts for Static Vacuum Insulated Piping System	DN10, 3/8"	8~16 bar	300 Series Stainless Steel	ASME B31.3	00: Design Pressure. 08 is 8bar, 16 is 16bar. X: Material of Inner Pipe. A is 304, B is 304L, C is 316, D is 316L, E is other.
HLPSF01500X		DN15, 1/2"				
HLPSF02000X		DN20, 3/4"				
HLPSF02500X		DN25, 1"				
HLPSF03200X		DN32, 1-1/4"				
HLPSF04000X		DN40, 1-1/2"				
HLPSF05000X		DN50, 2"				
HLPSF06500X		DN65, 2-1/2"				
HLPSF08000X		DN80, 3"				

Nominal Diameter of Inner Pipe: Recommended \leq DN80 or 3". Or selects the Welded Connection Type (from DN10, 3/8" to DN500, 20"), Vacuum Bayonet Connection Type with Clamps (from DN10, 3/8" to DN25, 1").

Nominal Diameter of Outer Pipe: Recommended by the Enterprise Standard of HL Cryogenic Equipment. It also can be produced according to requirement of the customer.

Design Pressure: Recommended \leq 16 bar. Or selects Welded Connection Type (\leq 64 bar).

Material of Outer Pipe: Without special requirement, the material of inner pipe and outer pipe will be selected the same.

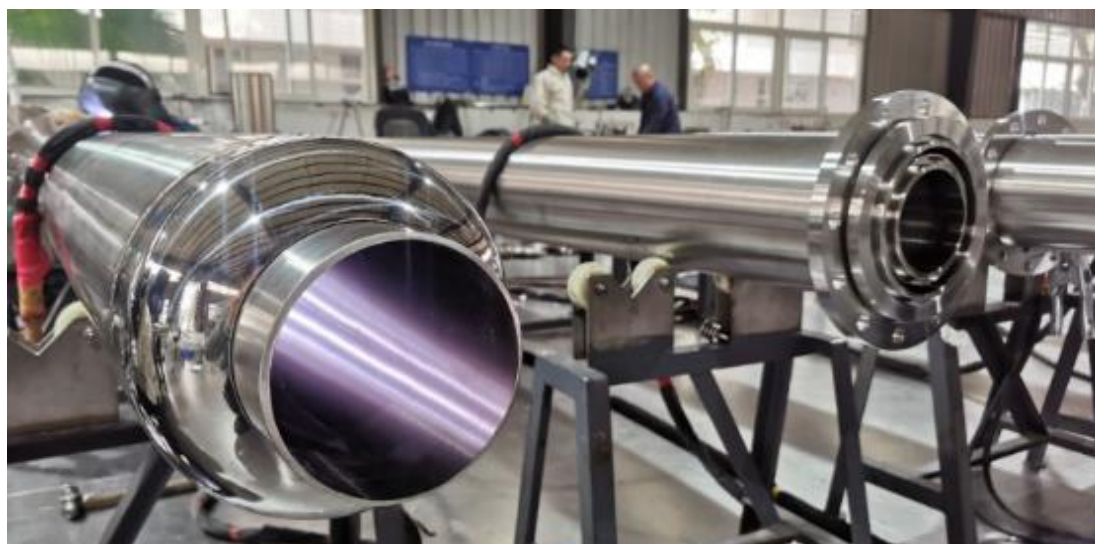

Product Introduction and Scope of Supply



Welded Connection Type of VI Pipe

Model	Connection Type	Nominal Diameter of Inner Pipe	Design Pressure	Material of Inner Pipe	Standard	Remark
HLP SW01000X	Welded Connection Type for Static Vacuum Insulated Piping System	DN10, 3/8"	8~64 bar	300 Series Stainless Steel	ASME B31.3	00: Design Pressure 08 is 8bar, 16 is 16bar, and 25, 32, 40, 64. X: Material of Inner Pipe. A is 304, B is 304L, C is 316, D is 316L, E is other.
HLP SW01500X		DN15, 1/2"				
HLP SW02000X		DN20, 3/4"				
HLP SW02500X		DN25, 1"				
HLP SW03200X		DN32, 1-1/4"				
HLP SW04000X		DN40, 1-1/2"				
HLP SW05000X		DN50, 2"				
HLP SW06500X		DN65, 2-1/2"				
HLP SW08000X		DN80, 3"				
HLP SW10000X		DN100, 4"				
HLP SW12500X		DN125, 5"				
HLP SW15000X		DN150, 6"				
HLP SW20000X		DN200, 8"				
HLP SW25000X		DN250, 10"				
HLP SW30000X		DN300, 12"				
HLP SW35000X		DN350, 14"				
HLP SW40000X		DN400, 16"				
HLP SW45000X	DN450, 18"					
HLP SW50000X	DN500, 20"					

Nominal Diameter of Outer Pipe: Recommended by the Enterprise Standard of HL Cryogenic Equipment. It also can be produced according to requirement of the customer.

Material of Outer Pipe: Without special requirement, the material of inner pipe and outer pipe will be selected the same.

**Product Introduction
and Scope of Supply**



Vacuum Insulated/Jacketed Flexible Hose

PRODUCT INTRODUCTION

AND SCOPE OF SUPPLY

FOR CHENGDU HOLY CRYOGENIC EQUIPMENT CO.,LTD.

2. Vacuum Insulated Flexible Hose

Vacuum Insulated Flexible Hose is made of 300 series stainless steel Hose.

Compared with Vacuum Insulated Pipe, it has good bending ability and can meet the installation requirements of various complex Spaces. On-site workers can easily and simply measure and drawing, and it will not affect the installation without the accurate data. Vacuum Insulated Flexible Hose can be replaced with each other because it does not need precise matching of length.

Compared with conventional piping insulation, Vacuum Insulated Flexible Hose has better bending and insulation effect.

Vacuum Insulated Flexible Hose can theoretically be made of infinite length. Reduce the number of joints in the VI system, so that resulting in less cooling loss. (The cooling loss at the Vacuum Bayonet Connection is significantly greater than the VI Hose/Pipe itself.)



2.1 Type of Connection

There are usually four connection types for VI Flexible Hose. The first three connection types apply only to the connection positions between VI Flexible Hoses. The fourth one, threaded connection type is generally used only for VI Hose connections to equipment and storage tank.

When VI Flexible Hose connects with equipment, storage tank and so on, the connection joint can be customized according to customer requirements.

	Vacuum Bayonet Connection Type with Clamps	Vacuum Bayonet Connection Type with Flanges and Bolts	Welded Connection Type	Thread Joint Connection Type
Connection Type	Clamps	Flanges and Bolts	Weld	Thread
Insulation Type at joints	Vacuum	Vacuum	Perlite or Vacuum	Wrapping Insulated Materials
On-site Insulated Treatment	No	No	Yes, perlite filled into or vacuum pump out from the Insulated Sleeves at joints.	Yes
Nominal Diameter of Inner Pipe	DN10(3/8")~DN25(1")	DN10(3/8")~DN80(3")	DN10(3/8")~DN150(6")	DN10(3/8")~DN25(1")
Design Pressure	≤8 bar	≤16 bar	≤40 bar	≤16 bar
Installation	Easy	Easy	Weld	Easy
Design Temperature	-196°C~ 60°C (LH2 & LHe : -270°C ~ 60°C)			
Length	≥ 1 meter/pcs			
Material	300 Series Stainless Steel			
Medium	LN ₂ , LOX, LAr, LHe, LH ₂ , LNG			

Pictures of Connection Types



Vacuum Bayonet Connection Type with Clamps



Vacuum Bayonet Connection Type with Flanges and Bolts



Thread Connection Type

2.2 Two Protective Covers

In addition, there are two kinds of Vacuum Insulated Flexible Hose outer protective cover, including the state without protective cover, there are three delivery states in total

Without the Protective Cover



Braided Protective Cover



Armored Protective Cover



2.3 Product Scope of Supply

Vacuum Insulated Flexible Hose

Product	Specification	Vacuum Bayonet Connection with Clamps	Vacuum Bayonet Connection with Flanges and Bolts	Weld Insulated Connection	Thread Connection
Vacuum Insulated Flexible Hose	DN8	YES	YES	YES	YES
	DN15	YES	YES	YES	YES
	DN20	YES	YES	YES	YES
	DN25	YES	YES	YES	YES
	DN32	/	YES	YES	/
	DN40	/	YES	YES	/
	DN50	/	YES	YES	/
	DN65	/	YES	YES	/
	DN80	/	YES	YES	/
	DN100	/	/	YES	/
	DN125	/	/	YES	/
	DN150	/	/	YES	/



Technical Characteristic of VI Pipe

Design Temperature	-196°C~90°C (LHe: -270°C~90°C)
Ambient Temperature	-50~90°C
Vacuum Leakage Rate	$\leq 1 \cdot 10^{-10} \text{Pa} \cdot \text{m}^3/\text{S}$
Vacuum Level after Guarantee	$\leq 0.1 \text{ Pa}$
Insulated Method	High Vacuum Multi-Layer Insulation.
Adsorbent and Getter	Yes
Test Pressure	1.15 Times Design Pressure
Medium	LO ₂ 、LN ₂ 、LAr、LH ₂ 、LHe、LEG、LNG



DN150 VI Braided Flexible Hose in manufacturing factory

2.4 Specification and Model

Vacuum Bayonet Connection Type with Clamps of VI Flexible Hose

Model	Connection Type	Nominal Diameter of Inner Pipe	Design Pressure	Material of Inner Pipe	Standard	Remark
HLHSB01008X	Vacuum Bayonet Connection Type with Clamps for Static Vacuum Insulated Flexible Hose	DN10, 3/8"	8 bar	300 Series Stainless Steel	ASME B31.3	X: Material of Inner Pipe. A is 304, B is 304L, C is 316, D is 316L, E is other.
HLHSB01508X		DN15, 1/2"				
HLHSB02008X		DN20, 3/4"				
HLHSB02508X		DN25, 1"				

Nominal Diameter of Inner Pipe: Recommended \leq DN25 or 1". Or selects the Vacuum Bayonet Connection Type with Flanges and Bolts (from DN10, 3/8" to DN80, 3"), Welded Connection Type (from DN10, 3/8" to DN150, 6")

Nominal Diameter of Outer Pipe: Recommended by the Enterprise Standard of HL Cryogenic Equipment. It also can be produced according to requirement of the customer.

Design Pressure: Recommended \leq 8 bar. Or selects the Vacuum Bayonet Connection Type with Flanges and Bolts (\leq 16 bar), Welded Connection Type (\leq 40 bar)

Material of Outer Pipe: Without special requirement, the material of inner pipe and outer pipe will be selected the same.



Product Introduction and Scope of Supply



Vacuum Bayonet Connection Type with Clamps of VI Flexible Hose

Model	Connection Type	Nominal Diameter of Inner Pipe	Design Pressure	Material of Inner Pipe	Standard	Remark
HLHSF01000X	Vacuum Bayonet Connection Type with Flanges and Bolts for Static Vacuum Insulated Flexible Hose	DN10, 3/8"	8~16 bar	300 Series Stainless Steel	ASME B31.3	00: Design Pressure. 08 is 8bar, 16 is 16bar. X: Material of Inner Pipe. A is 304, B is 304L, C is 316, D is 316L, E is other.
HLHSF01500X		DN15, 1/2"				
HLHSF02000X		DN20, 3/4"				
HLHSF02500X		DN25, 1"				
HLHSF03200X		DN32, 1-1/4"				
HLHSF04000X		DN40, 1-1/2"				
HLHSF05000X		DN50, 2"				
HLHSF06500X		DN65, 2-1/2"				
HLHSF08000X		DN80, 3"				

Nominal Diameter of Inner Pipe: Recommended \leq DN80 or 3". Or selects the Welded Connection Type (from DN10, 3/8" to DN150, 6"), Vacuum Bayonet Connection Type with Clamps (from DN10, 3/8" to DN25, 1").

Nominal Diameter of Outer Pipe: Recommended by the Enterprise Standard of HL Cryogenic Equipment. It also can be produced according to requirement of the customer.

Design Pressure: Recommended \leq 16 bar. Or selects Welded Connection Type (\leq 40 bar).

Material of Outer Pipe: Without special requirement, the material of inner pipe and outer pipe will be selected the same.



Product Introduction and Scope of Supply



Welded Connection Type of VI Flexible Hose

Model	Connection Type	Nominal Diameter of Inner Pipe	Design Pressure	Material of Inner Pipe	Standard	Remark
HLHSW01000X	Welded Connection Type for Static Vacuum Insulated Flexible Hose	DN10, 3/8"	8~40 bar	300 Series Stainless Steel	ASME B31.3	00: Design Pressure 08 is 8bar, 16 is 16bar, and 25, 32, 40. X: Material of Inner Pipe. A is 304, B is 304L, C is 316, D is 316L, E is other.
HLHSW01500X		DN15, 1/2"				
HLHSW02000X		DN20, 3/4"				
HLHSW02500X		DN25, 1"				
HLHSW03200X		DN32, 1-1/4"				
HLHSW04000X		DN40, 1-1/2"				
HLHSW05000X		DN50, 2"				
HLHSW06500X		DN65, 2-1/2"				
HLHSW08000X		DN80, 3"				
HLHSW10000X		DN100, 4"				
HLHSW12500X		DN125, 5"				
HLHSW15000X		DN150, 6"				

Nominal Diameter of Outer Pipe: Recommended by the Enterprise Standard of HL Cryogenic Equipment. It also can be produced according to requirement of the customer.

Material of Outer Pipe: Without special requirement, the material of inner pipe and outer pipe will be selected the same.



Product Introduction and Scope of Supply



Thread Connection Type of VI Flexible Hose

Model	Connection Type	Nominal Diameter of Inner Pipe	Design Pressure	Material of Inner Pipe	Standard	Remark
HLHST01000X	Vacuum Bayonet Connection Type with Clamps for Static Vacuum Insulated Flexible Hose	DN10, 3/8"	8~16 bar	300 Series Stainless Steel	ASME B31.3	00: Design Pressure. 08 is 8bar, 16 is 16bar.
HLHSB01500X		DN15, 1/2"				X: Material of Inner Pipe.
HLHSB02000X		DN20, 3/4"				A is 304, B is 304L,
HLHSB02500X		DN25, 1"				C is 316, D is 316L, E is other.

Nominal Diameter of Inner Pipe: Recommended \leq DN25 or 1". Or selects the Vacuum Bayonet Connection Type with Flanges and Bolts (from DN10, 3/8" to DN80, 3"), Welded Connection Type (from DN10, 3/8" to DN150, 6")

Nominal Diameter of Outer Pipe: Recommended by the Enterprise Standard of HL Cryogenic Equipment. It also can be produced according to requirement of the customer.

Design Pressure: Recommended \leq 16 bar. Or selects the Welded Connection Type (\leq 40 bar)

Material of Outer Pipe: Without special requirement, the material of inner pipe and outer pipe will be selected the same.



**Product Introduction
and Scope of Supply**



Dynamic Vacuum System

PRODUCT INTRODUCTION

AND SCOPE OF SUPPLY

FOR CHENGDU HOLY CRYOGENIC EQUIPMENT CO.,LTD.



3.1 Dynamic Vacuum System

Vacuum Insulated System, including VI Piping and VI Flexible Hose System, can be divided into Dynamic and Static VI System.

- The Static VI System is fully completed in the manufacturing factory.
- The Dynamic VI System is offered a more stable vacuum state by a continuous pumping of vacuum pump system on site, and vacuuming treatment will no longer take place in the factory. The rest of the assembly and process treatment is still in the manufacturing factory. So, the Dynamic VJ Piping needs to be equipped with a Vacuum Pump System.

	Dynamic Vacuum Insulated Piping System	Static Vacuum Insulated Piping System
Introduction	The vacuum degree of the vacuum interlayer is monitored continuously, and the vacuum pump is automatically controlled to open and close, to ensure the stability and effectiveness of vacuum degree	VJPs complete the vacuum insulation work in the manufacturing plant.
Advantages	The vacuum retention is more stable, basically eliminate the vacuum maintenance in the future working.	More economical investment and simple on-site installation
Vacuum Bayonet Connection Type with Clamps	Applicative	Applicative
Vacuum Bayonet Connection Type with Flanges and Bolts	Applicative	Applicative
Welded Connection Type	Applicative	Applicative

Compare to the Static VJ Piping, The Dynamic VJ Piping maintains a long-term stable vacuum state and does not decrease with time through the continuous pumping of the Vacuum Pump System. So, the Vacuum Pump System as the important supporting equipment provides the normal operation of the Dynamic VI Piping System. Accordingly, the cost is higher.



Vacuum Pump for Dynamic Vacuum System

The Dynamic Vacuum Pump (including the 2 vacuum pumps, 2 solenoid valves and 2 vacuum gauges) is an important part of the Dynamic VJ Piping System.

The advantage of the Dynamic Vacuum System is that it reduces the maintenance work of the VI Piping and VI Hose in the future. Especially, VI Piping and VI Hose are installed in the floor interlayer, the space is too small to maintain. So, the Dynamic Vacuum System is the best choice.

The Dynamic Vacuum Pump System will monitor the vacuum degree of the whole piping system in real time. HL Cryogenic Equipment chooses the high-power vacuum pumps, so that the vacuum pumps will not always be in working state, prolonging the service life of the equipment.

Product Introduction and Scope of Supply



The role of Jumper Hose in Dynamic VJ Piping is to connect the vacuum chambers to facilitate the vacuum pump to pump-out. The V-band clamps are often used for Jumper hose connections



**Product Introduction
and Scope of Supply**



Vacuum Insulated Phase Separator

PRODUCT INTRODUCTION

AND SCOPE OF SUPPLY

FOR CHENGDU HOLY CRYOGENIC EQUIPMENT CO.,LTD.

4. Vacuum Insulated Phase Separator

HL Cryogenic Equipment Company has three kinds of Vacuum Insulated Phase Separator, their name are,

- VI Phase Separator
- VI Degasser
- VI Automatic Gas Vent
- VI Phase Separator for MBE System

No matter which kind of the Vacuum Insulated Phase Separator, it is one of the most common equipment of Vacuum Insulated Cryogenic Piping System. The phase separator is mainly to separate the gas from the cryogenic liquid, which can ensure,

1. Liquid supply volume and speed: Eliminate insufficient liquid flow and velocity caused by gas barrier.
2. Incoming temperature of terminal equipment: eliminate the temperature instability of cryogenic liquid due to slag inclusion in gas, which leads to the production conditions of terminal equipment.
3. Pressure adjustment (reducing) and stability: eliminate the pressure fluctuation caused by the continuous formation of gas.

In a word, VI Phase Separator function is to meet the requirements of the terminal equipment for liquid nitrogen, including flow rate, pressure, and temperature and so on.

The Phase Separator is a mechanical structure and system that does not require pneumatic and electrical source. Usually choose 304 stainless steel production, can also choose other 300 series stainless steel according to the requirements. The Phase Separator is mainly used for liquid nitrogen service and recommended to be placed at the highest point of the piping system to ensure maximum effect, since gas has a lower specific gravity than liquid.

4.1 Three Kinds of Phase Separators

4.1.1 Vacuum Insulated Phase Separator

VI Phase Separator a Separator with the function of regulating pressure and controlling flow rate. If the terminal equipment has higher requirements for liquid nitrogen through VI Piping, such as pressure, temperature, etc., it needs to be considered.

Major Parameter

Model	HLSR1000
Maximum Volume	40 L
Output Pressure of Gas	According to user requirements
Diameter of Input Pipe (Liquid in)	DN25~DN50
Diameter of Vent Pipe (Gas out)	DN40~DN65
Diameter of Output Pipe (Liquid out)	DN15~DN50
Flow of Liquid Nitrogen	Depending on pipe diameter and pressure
Materials	304
Layer No. of Insulated Material	30
Vacuum of Jacketed Chamber	$\leq 6 \times 10^{-2} \text{Pa}$ (20°C) $\leq 2 \times 10^{-2} \text{Pa}$ (-196°C)
Leakage Rate of Vacuum	$\leq 1 \times 10^{-10} \text{Pa} \cdot \text{m}^3/\text{s}$
Heat Loss When Filling Liquid Nitrogen	265 W/h
Heat Loss When Is Stable	20 W/h

Product Introduction and Scope of Supply

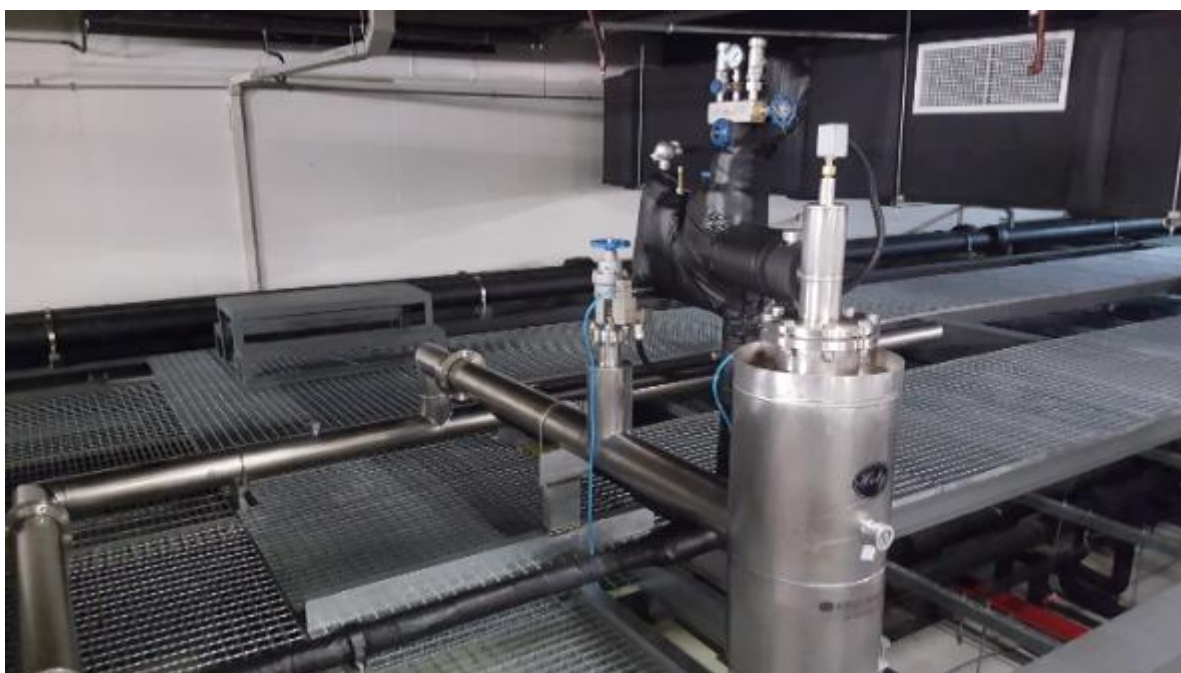
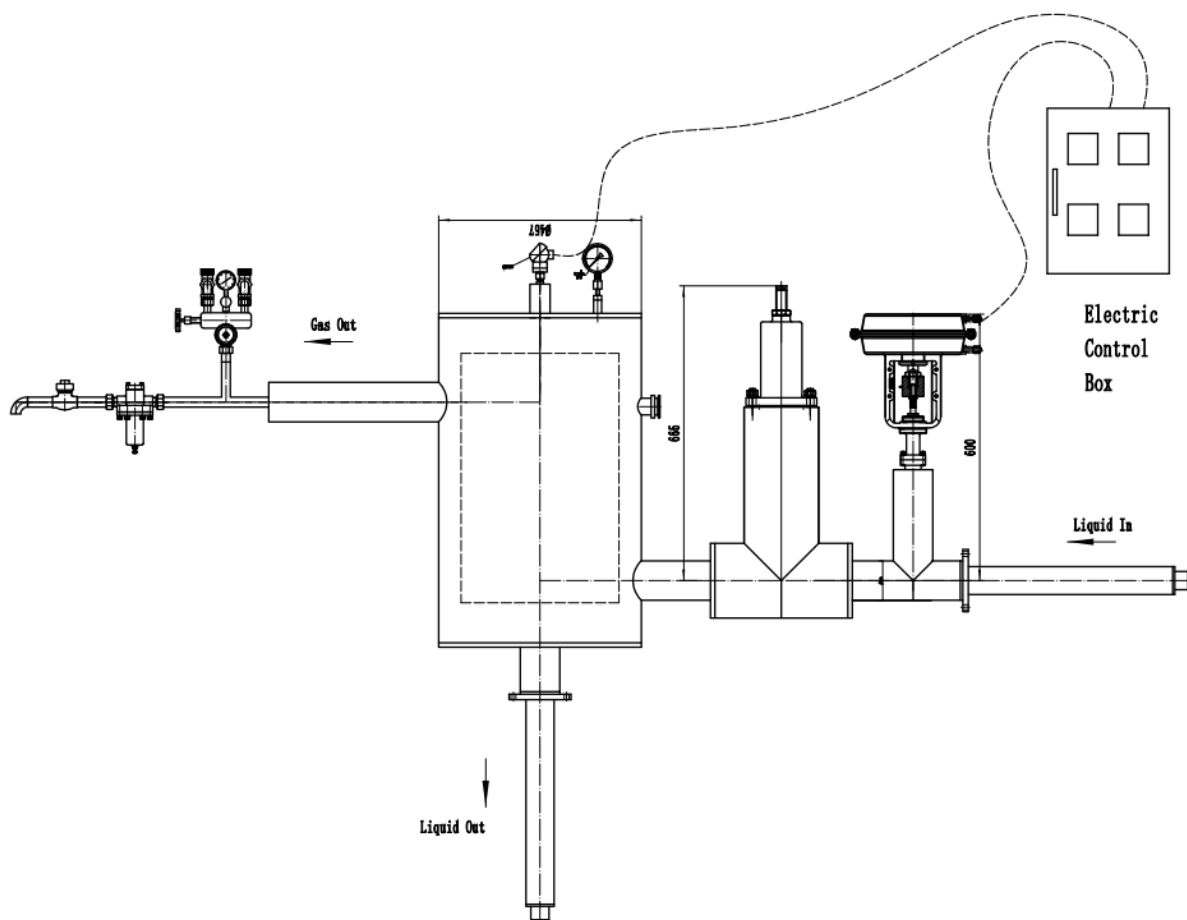

4.1.2 VI Degasser

VI Degasser needs to be installed at the highest point of VI Piping. It has 1 Input Pipe (Liquid), 1 Output Pipe (Liquid) and 1 Vent Pipe (Gas). It works on buoyancy principle, so no power is needed, and also does not have the function of regulating pressure and flow.

Major Parameter

Model	HLSP1000
Maximum Volume	40 L
Pressure Regulating Function	No
Diameter of Input Pipe (Liquid)	DN25~DN50
Diameter of Vent Pipe (Gas)	DN40~DN65
Diameter of Output Pipe (Liquid)	DN15~DN50
Flow of Liquid Nitrogen	Depending on pipe diameter and pressure
Materials	304
Layer No. of Insulated Material	30
Vacuum of Jacketed Chamber	$\leq 6 \times 10^{-2}$ Pa (20°C) $\leq 2 \times 10^{-2}$ Pa (-196°C)
Leakage Rate of Vacuum	$\leq 1 \times 10^{-10}$ Pa.m ³ /s
Heat Loss When Filling Liquid Nitrogen	265 W/h
Heat Loss When Is Stable	20 W/h

Product Introduction and Scope of Supply

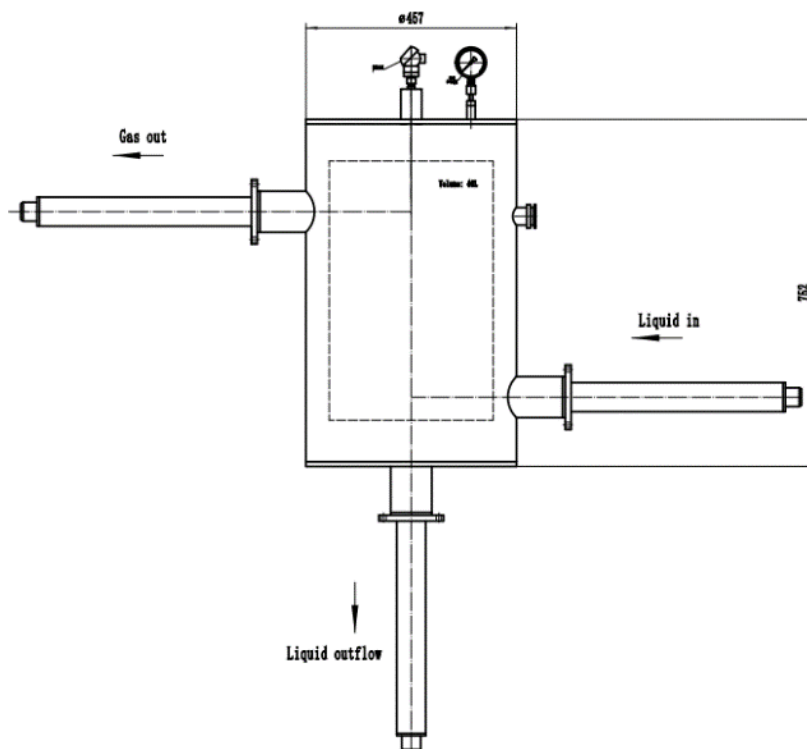

4.1.3 VI Automatic Gas Vent

VI Automatic Gas Vent is placed at the end of the VI Pipe line. So there is only 1 Input Pipe (Liquid) and 1 Vent Pipe (Gas). Like Degasser, It works on buoyancy principle, so no power is needed, and also does not have the function of regulating pressure and flow.

Major Parameter

Model	HLSP500
Maximum Volume	20 L
Diameter of Input Pipe (Liquid)	DN25~DN50
Diameter of Vent Pipe (Gas)	DN40~DN65
Flow of Liquid Nitrogen	Depending on pipe diameter and pressure
Materials	304
Layer No. of Insulated Material	30
Vacuum of Jacketed Chamber	$\leq 6 \times 10^{-2} \text{Pa}$ (20°C) $\leq 2 \times 10^{-2} \text{Pa}$ (-196°C)
Leakage Rate of Vacuum	$\leq 1 \times 10^{-10} \text{Pa.m}^3/\text{s}$
Heat Loss When Filling Liquid Nitrogen	190W/h
Heat Loss When Is Stable	14 W/h

Product Introduction and Scope of Supply

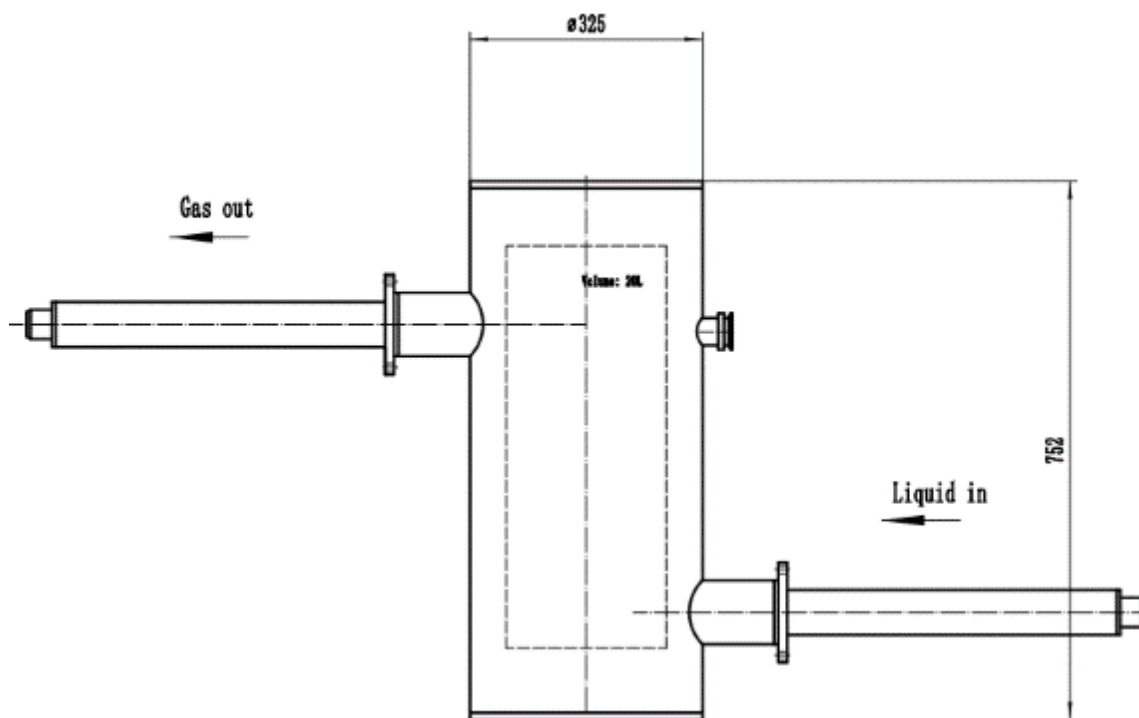

4.1.4 Phase Separator for MBE System

This is a dedicated device for MBE projects in the chip industry.

Major Parameter

Model	HLSC1000
Maximum Volume	50 L
Output Pressure of Liquid in PS	1.5 Bar
Diameter of Input Pipe (Liquid) in PS	DN25
Diameter of Vent Pipe (Gas) in PS	DN40
Diameter of Output Pipe (Liquid) in Circulating System	DN15
Diameter of Input Pipe (Gas) in Circulating System	DN20
Flow of Liquid Nitrogen	270 L/h
Materials	304
Layer No. of Insulated Material	30
Vacuum of Jacketed Chamber	$\leq 6 \times 10^{-2}$ Pa (20°C) $\leq 2 \times 10^{-2}$ Pa (-196°C)
Leakage Rate of Vacuum	$\leq 1 \times 10^{-10}$ Pa.m ³ /s
Heat Loss When Filling Liquid Nitrogen	300 W/h
Heat Loss When Is Stable	22 W/h
Number of Output Pipe Connection (Liquid) in Circulating System	1 ~ 6
Number of Input Pipe Connection (Gas) in Circulating System	1 ~ 6

Product Introduction and Scope of Supply



**Product Introduction
and Scope of Supply**



Vacuum Insulated Valve Series

PRODUCT INTRODUCTION

AND SCOPE OF SUPPLY

FOR CHENGDU HOLY CRYOGENIC EQUIPMENT CO.,LTD.

5.1 Vacuum Insulated Shut-off Valve

The Vacuum Insulated Shut-off / Stop Valve is the most widely used for VI valve series in the VI Piping and VI Hose System. It is responsible for controlling the opening and closing of main and branch pipelines.

It, simply speaking, is put a vacuum jacket on the cryogenic valve. In the manufacturing plant, VI Shut-off Valve and VI Pipe/Hose are prefabricated into one pipeline, and there is no need for installation and insulated treatment on site. For maintenance, the seal unit of VI Shut-off Valve can be replaced easily without damaging its vacuum chamber.

(* We accepts the cryogenic valve brand designated by customers, and then makes vacuum insulated valves by us. Some brands/models may not be able to be made into vacuum insulated valves.)

Model	HLVS000 Series
Name	Vacuum Insulated Shut-off Valve
Nominal Diameter	DN15 ~ DN150 (1/2" ~ 6")
Design Pressure	≤40bar (4.0MPa)
Design Temperature	-196°C ~ 60°C (LH ₂ & LHe : -270°C ~ 60°C)
Medium	LN ₂ , LOX, LAr, LHe, LH ₂ , LNG
Material	Stainless Steel 304
On-site Installation	No
On-site Insulated Treatment	No



5.2 Vacuum Insulated Pneumatic Shut-off Valve

The Vacuum Insulated shut-off Valve is a VI shut-off Valve controlled by gas to start and close. Therefore, the existing need to be equipped with air compressor. It is a good choice when it is necessary to cooperate with PLC for automatic control or when the valve position is not convenient for personnel to operate.

It, simply speaking, is put a vacuum jacket on the cryogenic Shut-off Valve and added a set of cylinder system. In the manufacturing plant, VI Pneumatic Shut-off Valve and the VI Pipe or Hose are prefabricated into one pipeline, and there is no need for installation with pipeline and insulated treatment on site.

(* We accepts the cryogenic valve brand designated by customers, and then makes vacuum insulated valves by us. Some brands/models may not be able to be made into vacuum insulated valves.)

Model	HLVSP000 Series
Name	Vacuum Insulated Pneumatic Shut-off Valve
Nominal Diameter	DN15 ~ DN150 (1/2" ~ 6")
Design Pressure	≤40bar (4.0MPa)
Design Temperature	-196°C~ 60°C (LH ₂ & LHe : -270°C ~ 60°C)
Cylinder Pressure	3bar ~ 14bar (0.3 ~ 1.4MPa)
Medium	LN ₂ , LOX, LAr, LHe, LH ₂ , LNG
Material	Stainless Steel 304
On-site Installation	No, connect to air source.
On-site Insulated Treatment	No



5.3 Vacuum Insulated Pressure Regulating Valve

The VI Pressure Regulating Valve is widely used when the pressure of the storage tank is unsatisfied, and/or the terminal equipment needs to control the incoming liquid data etc.

When the pressure of storage tank does not meet the requirements, including the requirements of delivery pressure and terminal equipment pressure, VI Pressure Regulating Valve can adjust the pressure in the VI piping. This adjustment can be either to reduce or to boost to the required pressure. The adjustment value can be set according to the need. The pressure can be easily adjusted mechanically using conventional tools.

Model	HLVP000 Series
Name	Vacuum Insulated Pressure Regulating Valve
Nominal Diameter	DN15 ~ DN150 (1/2" ~ 6")
Design Temperature	-196°C ~ 60°C
Medium	LN ₂
Material	Stainless Steel 304
On-site Installation	No,
On-site Insulated Treatment	No



5.4 Vacuum Insulated Flow Regulating Valve

The Vacuum Insulated Flow Regulating Valve is widely used control the quantity, pressure and temperature of cryogenic liquid according to the requirements of terminal equipment.

Compared with the VI Pressure Regulating Valve, the VI Flow Regulating Valve and PLC system can be intelligent real-time control of cryogenic liquid data. According to the liquid requirement of terminal equipment, adjust the valve opening degree in real time to meet the needs of customers for more accurate control.

Model	HLVF000 Series
Name	Vacuum Insulated Flow Regulating Valve
Nominal Diameter	DN15 ~ DN40 (1/2" ~ 1-1/2")
Design Temperature	-196°C~ 60°C
Medium	LN ₂
Material	Stainless Steel 304
On-site Installation	No,
On-site Insulated Treatment	No



5.5 Vacuum Insulated Check Valve

The Vacuum Insulated Check Valve is used when liquid medium is not allowed to flow back.

Cryogenic liquids and gases in the VI pipeline are not allowed to flow back when cryogenic storage tanks or equipment under safety requirements. The backflow of cryogenic gas and liquid may cause excessive pressure and damage to equipment. At this time, it is necessary to equip the Vacuum Insulated Check Valve at the appropriate position in the vacuum insulated pipeline to ensure that the cryogenic liquid and gas will not flow back beyond this point.

In the manufacturing plant, Vacuum Insulated Check Valve and the VI pipe or hose prefabricated into a pipeline, without on-site pipe installation and insulation treatment.

Model	HLVC000 Series
Name	Vacuum Insulated Check Valve
Nominal Diameter	DN15 ~ DN150 (1/2" ~ 6")
Design Temperature	-196°C~ 60°C (LH ₂ & LHe: -270°C ~ 60°C)
Medium	LN ₂ , LOX, LAr, LHe, LH ₂ , LNG
Material	Stainless Steel 304
On-site Installation	No,
On-site Insulated Treatment	No



5.6 Vacuum Insulated Valve Box

In the case of several valves with limited space and complex conditions, the Vacuum Insulated Valve Box centralizes the valves for unified insulated treatment. Therefore, it needs to be customized according to different system conditions and customer requirements.

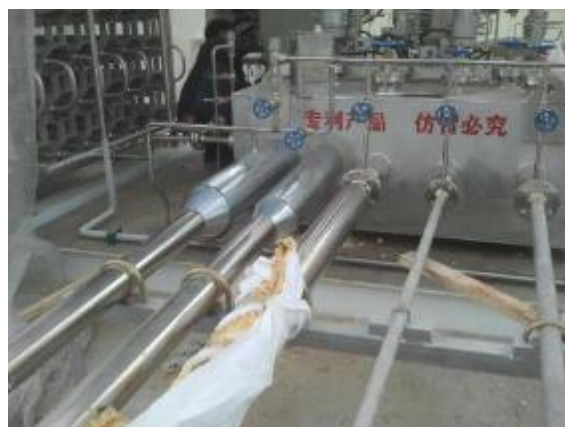

**Product Introduction
and Scope of Supply**



Accessories Series

PRODUCT INTRODUCTION

AND SCOPE OF SUPPLY

FOR CHENGDU HOLY CRYOGENIC EQUIPMENT CO.,LTD.

6.1 Vacuum Insulated Filter

The VI Filter can effectively prevent the damage caused by impurities and ice residue to the terminal equipment and sealing face of valve core, and improve the service life of the terminal equipment. In particular, it is strongly recommend for high value terminal equipment.

The reason why the ice slag appears in the storage tank and vacuum Insulated piping is that when the cryogenic liquid is filled at the first time, the air in the storage tanks or VI piping is not exhausted in advance, and the moisture in the air freezes when it gets cryogenic liquid. Therefore, it is highly recommended to installing a vacuum insulated filter for either the first time or the recovery equipment again when it is injected with cryogenic liquid.

Model	HLEF000 Series
Nominal Diameter	DN15 ~ DN150 (1/2" ~ 6")
Design Pressure	≤40bar (4.0MPa)
Design Temperature	60°C ~ -196°C
Medium	LN ₂
Material	300 Series Stainless Steel
On-site Installation	No
On-site Insulated Treatment	No



6.2 Venting Pipe Heater

The Venting Pipe Heater is installed at the end of the venting pipe of the phase separator and used to heat the cryogenic gas to prevent frosting and large amounts of white fog from the gas vent, and improve the safety of the production environment. Especially, when the outlet of phase separator is indoors, the vent heater is more necessary to heat the low temperature nitrogen gas.

In addition to the above potential problems, the white fog discharged from the gas vent which is placed in the public area will cause panic of others. The elimination of white fog by the Vent Heater can effectively eliminate the safety concerns of others.

The heater uses electricity to provide heat and material is 304 stainless steel, and the temperature can be adjusted. The heater can be customized according to the use of the field voltage and other power specifications.



6.3 Safety Relief Valve (Group)

A Safety Relief Valve or Safety Relief Valve Group must be placed between two shut-off valves. Prevent cryogenic liquid vaporization and pressure boost in VI pipeline after both ends of valves are shut off at the same time, leading to damage to equipment and safety hazards.

The Safety Relief Valve Group is composed of two safety relief valves, a pressure gauge, and a shut-off valve with a manual discharge port. Compared to a single safety relief valve, it can be repaired and operated separately when the VI Piping is working.

Users can purchase the Safety Relief Valves by yourselves, and HL reserves the installation connector of the Safety Relief Valve on the VI Piping.

Model	HLER000 Series
Nominal Diameter	DN8 ~ DN25 (1/4" ~ 1")
Working Pressure	Adjustable according to user needs
Medium	LN ₂ , LOX, LAr, LHe, LH ₂ , LNG
Material	Stainless Steel 304
On-site Installation	No



6.4 Vacuum Insulated Gas-liquid Barrier

The Vacuum Gas-liquid Barrier is placed in the vertical VJ pipe at the end of VJ piping. The Gas-liquid Barrier uses the gas seal principle to block the heat from the end of the VJ pipe into the whole VJ Piping, and effectively reduce the loss of liquid nitrogen during discontinuous and intermittent service of the system.

Because there is usually a small section of non-vacuum pipe at the end of the VJ piping where it is connected to the terminal equipment, this part of the non-vacuum pipe will bring a huge heat loss to the whole vacuum system. A difference of more than 200 degrees Celsius between the ambient temperature and the liquid nitrogen of -196 °C would result in significant gasification (loss of liquid nitrogen) in the VJ piping, while the large amount of vaporization would also cause pressure instability in the VJ piping.

The vacuum gas-liquid barrier is designed to limit this heat transfer into the VJ piping and to minimize liquid nitrogen losses during frequent discontinuous use of liquid nitrogen in terminal equipment.

The Gas-liquid Barrier does not require power to operate. It and VI Pipe or Hose are prefabricated into one pipeline in the manufactory, and there is no need for installation and insulated treatment on site.



Model	HLEB000 Series
Nominal Diameter	DN10 ~ DN25 (1/2" ~ 1")
Medium	LN ₂
Material	300 Series Stainless Steel
On-site Installation	No
On-site Insulated Treatment	No

6.5 Special Connector for Cold-box and Storage Tank

The Special Connector for Cold-box and Storage Tank can take the place of on-site insulated treatment when the VJ Piping is connected to equipment. At the junction position, the effect of on-site insulation work is often not very good. The Special Connector for Cold-box and Storage Tank is developed for this purpose.

The Special Connector can minimize cold loss, avoid icing and frost, prevents the corrosion and reduces the loss of liquid gasification and simple installation with a beautiful appearance.

The Special Connector for Cold-box and Storage Tank is a very mature product and has been successfully applied in many projects for more than 15 years.

Special Connector for Cold-box

Model	HLECA000 Series
Description	The Special Connector for Coldbox
Nominal Diameter	DN25 ~ DN150 (1/2" ~ 6")
Design Temperature	-196°C~ 60°C (LH ₂ & LHe : -270°C ~ 60°C)
Medium	LN ₂ , LOX, LAr, LHe, LH ₂ , LNG
Material	300 Series Stainless Steel
On-site Installation	Yes
On-site Insulated Treatment	No



Product Introduction and Scope of Supply



Special Connector for Storage Tank

Model	HLEB000 Series
Nominal Diameter	DN10 ~ DN25 (1/2" ~ 1")
Medium	LN ₂
Material	300 Series Stainless Steel
On-site Installation	No
On-site Insulated Treatment	No



6.6 Cryogenic Liquid Vaporizer

Cryogenic Liquid Vaporizer turns cryogenic liquid gas into gaseous gas by "heating" it through themselves. The principle of natural ventilation vaporizer is to use the flow of air to heat the cold liquid gas in itself, so as to convert the liquid gas into gaseous gas.

Especially in a large number of industrial scenarios where liquid nitrogen needs to be quickly converted to nitrogen, so Cryogenic Liquid Vaporizer are necessary.

In addition, Cryogenic Liquid Vaporizer can also be regarded as a Venting Pipe Heater that does not need power supply. In places without power supply, Venting Pipe Heater cannot be chosen, but Vaporizer can be chosen. The Vaporizer heats a large amount of nitrogen from Phase Separator through its own heating to eliminate cryogenic nitrogen

Cryogenic Liquid Vaporizer models and specifications need to be customized according to the amount used by customer.



Product Introduction and Scope of Supply		



Products and Solutions in Some Special Industries

PRODUCT INTRODUCTION

AND SCOPE OF SUPPLY

FOR CHENGDU HOLY CRYOGENIC EQUIPMENT CO.,LTD.

7.1 MBE Project in Chip & Semiconductor Industry



The technology of Molecular Beam Epitaxy (MBE) was developed in the 1950s to prepare semiconductor thin film materials using vacuum evaporation technology. With the development of ultra-high vacuum technology, the application of technology has been extended to the field of semiconductor science.

HL Cryogenic Equipment Company has noticed the demand of MBE liquid nitrogen cooling system, organized technical backbone to successfully develop a special MBE liquid nitrogen cooling system for MBE technology and a complete set of vacuum insulated piping system, which has been used in many enterprises, universities and research institutes.



7.2 Air Separation Plants

In large Industrial Parks, Iron and Steel Plants, Oil and Coal Chemical Plants and other places, it is necessary to set up Air Separation Plants to provide them with liquid oxygen (LO₂), liquid nitrogen (LN₂), liquid argon (LAr) or liquid helium (LHe) in production.

Chengdu Holy Cryogenic Equipment Co.,Ltd (HL Cryogenic Equipment) provides customers with the Vacuum Insulated Piping System to meet the requirements and conditions of large plants:

1. Quality Management System: ASME B31.3 Pressure Piping Code.
2. Long Transferring Distance: High requirement of vacuum insulated capacity to minimize gasification loss.
3. Long conveying distance: it is necessary to consider the contraction and expansion of the inner pipe and the outer pipe in cryogenic liquid and under the sun. The maximum working temperature can be designed at -270°C~90°C, usually -196°C~60°C.



4. Large Flow: The largest inner pipe of VIP can be designed and manufactured the diameter of DN500 (20").
5. Uninterrupted Working Day & Night: It has high requirements on the anti-fatigue of the Vacuum Insulated Piping System. HL has improved the design standards of flexible pressure elements, such as the design pressure of VIP is 1.6MPa (16bar), the design pressure of compensator is at least 4.0MPa (40bar), and for the compensator to increase the design of strong structure.
6. Connection with the Pump System: The highest design pressure is 6.4Mpa (64bar), and it needs a compensator with reasonable structure and strong capacity to bear high pressure.
7. Various Connection Types: Vacuum Bayonet Connection, Vacuum Socket Flange Connection and Welded Connection can be selected. For safety reasons, the Vacuum Bayonet Connection and the Vacuum Socket Flange Connection is not recommended to be used in the pipeline with large diameter and high pressure.
8. The Vacuum Insulated Valve (VIV) Series Available: Including Vacuum Insulated (Pneumatic) Shut-off Valve, Vacuum Insulated Check Valve, Vacuum Insulated Regulating Valve etc. Various types of VIV can be modular combined to control the VIP as required.



7.3 Liquefied Natural Gas (LNG) Industry

In order to reduce carbon emissions, the whole world is looking for clean energy that can replace petroleum energy, and LNG (Liquefied Natural Gas) is one of the important choices. HL launches the Vacuum Insulation Pipe (VIP) and supporting Vacuum Valve Control System for transferring LNG to meet the market demand.

Chengdu Holy Cryogenic Equipment Co.,Ltd (HL Cryogenic Equipment) has 10 years of experience in LNG projects. The Vacuum Insulated Pipe (VIP) is built to ASME B31.3 Pressure Piping code as a standard. Engineering experience and quality control ability to ensure the efficiency and cost-effectiveness of the customer's plant.

Contribute to the promotion of clean energy. So far, HL has participated in the construction of more than 100 gas filling stations and more than 10 liquefaction plants.



7.4 Cryogenic Assembly in Automotive Engine/Motor Rotor Industry

The engine seat and rotor of the motor are soaked in liquid nitrogen for freezing. Then the parts that shrink from freezing are taken out for quick assembly.

Compared with hot assembly, cryogenic-assembled parts have less deformation probability and longer service life in future use.

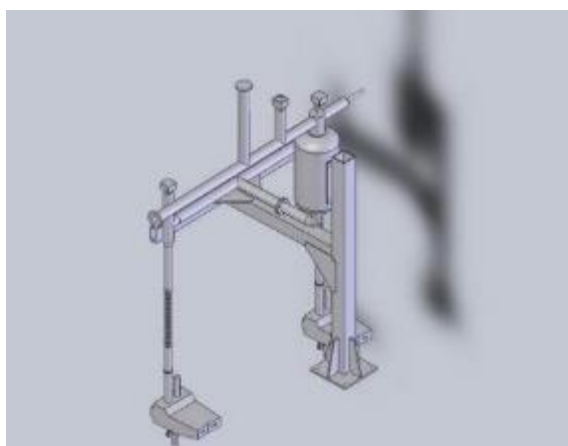

7.5 Lamp Manufacturing Industry

The rare gases are pumped into the light bulbs to make their service-life longer and brighter. In the process of filling the rare gases, the light bulbs need to be frozen, so that it can be filled with larger amounts of the rare gases. In this freezing process, liquid nitrogen is used.

There are two main types of terminal equipment for freezing light bulbs. One is sprayed with liquid nitrogen and the other is soaked in liquid nitrogen. The liquid nitrogen requirements of the two types of terminal equipment are different, which will affect the design of the Vacuum Insulated Piping System for liquid nitrogen.

Frozen light bulb



Test before delivery



7.6 Bioengineering and Pharmacy Industry

Liquid nitrogen is widely used in bioengineering and pharmacy industries. Liquid nitrogen is needed for stem cell storage, gene therapy and drug production. Therefore, vacuum insulated piping system is also required

Chengdu Holy Cryogenic Equipment Co.,Ltd (HL Cryogenic Equipment) provides customers with the Vacuum Insulated Piping System to meet the requirements and conditions of biopharmaceutical industry:

1. Quality Management System: ASME B31.3 Pressure Piping Code.
2. VI Piping Controlled by The Vacuum Insulated Valve (VIV) Series: Including Vacuum Insulated (Pneumatic) Shut-off Valve, Vacuum Insulated Check Valve, Vacuum Insulated Regulating Valve etc. Various types of VIV can be modular combined to control the VIP as required. VIV is integrated with VIP prefabrication in manufacturer, without on-site Insulated treatment. The seal unit of VIV can be replaced easily. (HL accepts the cryogenic valve brand designated by customers, and then makes vacuum insulated valves by HL. Some brands and models of valves may not be able to be made into vacuum insulated valves.)



3. Various types of Vacuum Phase Separator meet the requirements of gas-liquid separation under different working conditions. Ensure the stability of liquid pressure and temperature in VI Piping.

4. Cleanliness, if there are additional requirements for inner tube surface cleanliness. It is suggested that customers choose BA or EP stainless steel pipes as VIP inner pipes to further reduce stainless steel spillage.
5. Vacuum Insulated Filter: Clean away the possible impurities and ice residue from tank.
6. After a few days or longer shutdown or maintenance, it is very necessary to precool the VI Piping and terminal equipment before cryogenic liquid is entered, so as to avoid ice slag after cryogenic liquid directly enters the VI Piping and terminal equipment. Precooling function should be considered in design. It provides better protection for terminal equipment and VI Piping support equipment such as valves.
7. Suit for both Dynamic and Static Vacuum Insulated (Flexible) Piping System.
8. Dynamic Vacuum Insulated (Flexible) Piping System: Consist of VI Flexible Hoses and/or VI Pipe, Jumper Hoses, Vacuum Insulated Valve System, Phase Separators and Dynamic Vacuum Pump System (including the vacuum pumps, solenoid valves and vacuum gauges etc.). The length of single VI Flexible Hose can be customized according to user' s requirements.
9. Various Connection Types: Vacuum Bayonet Connection (VBC) Type and Welded Connection can be selected. The VBC type do not need on-site insulated treatment.



Product Introduction and Scope of Supply		



Chengdu Holy Cryogenic Equipment Co.,Ltd (HL Cryogenic Equipment) which was founded in 1992 is a brand affiliated to Chengdu Holy Cryogenic Equipment Company in China. HL Cryogenic Equipment is committed to the design and manufacture of the High Vacuum Insulated Cryogenic Piping System and related Support Equipment.